

## Lindab **LCP (-P, -T, -P-T)**

Installation instruction - UK  
Installations vejledning - DK  
Montageinstruktion - SE  
Asennusohje - FI  
Montageanleitung - DE  
Istruzioni di montaggio - IT  
Instructions de montage - FR



# Integra

# LCP

## Contents

### Indhold

### Innehållsförteckning

### Sisällysluettelo

### Inhalt

### Sommario

### Sommaire

Overview ceiling diffusers / Oversigt loft armaturer / Översikt takdon / Yleiskatsaus kattohajottajat /  
 Übersicht Deckendurchlässe / Panaoramica diffusore a soffitto / Aperçu diffuseurs plafonniers.....2

LCP (-P, -T, -P-T).....3

Accessories / Tilbehør / Tillbehör / Tilauksesta / Zubehör / Accessori / Accessoires.....4

Ceiling systems / loftsystemer / Undertakssystem / Kattojärjestelmät / Deckensysteme /  
 Sistemi di controsoffitto / Systèmes de plafond.....5

Installation of MB + diffuser / Installation af MB + armatur /  
 Montering av MB + don / Asennusohje MB + hajottaja / Montage der MB + Durchlass /  
 Montaggio MB + diffusore / Montage de MB + diffuseur.....6

## LCP LKP LCC

Ceiling diffusers suitable for Pascal/ Loft armaturer egnet til Pascal/ Takdon lämpliga for Pascal /  
 Pascal-järjestelmään soveltuvat kattohajottajat / Deckendurchlässe für Pascal geeignet /  
 Diffusori a soffitto adatti per Pascal / Diffuseurs plafonniers adaptables à Pascal



**LCP**  
LCP -P, -T, -P-T





**LKP**  
LKP -P



**LCC**  
LCC -P, -T, -P-T

## Symbols Symboler Symboler Symbolit Symbole Simboli Symboles

 +  2 x sensor - 2 x sensor - 2 x sensor  
 2 x antureita - 2 x Melder - 2 x Sensora  
 -P-T 2 x Détecteur

 Presence sensor - Bevægelsessensor  
 Nävarosensor - Liiketunnistin - Präsenzmelder  
 -P Sensora di presenza - Détecteur de présence

 Temperature sensor - Temperatursensor  
 Temperatursensor - Lämpötila-anturi - Temperaturmelder  
 -T Sensora di temperatura - Détecteur de température

# Integra

# LCP

Measure/weight  
Mål/vægt  
Mått/vikt  
Mitta/paino  
Abmessungen/Gewicht  
Misure/peso  
Dimensions / poids

Ød mm	kg
125	3.2
160	3.2
200	3.3
250	3.4
315	3.5

LCP

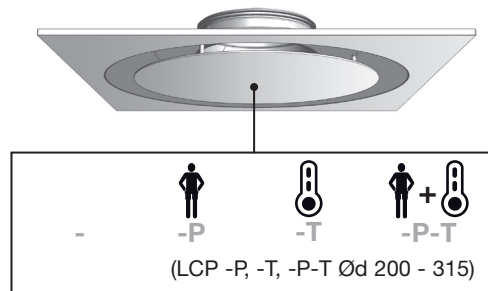

LCP + MBV

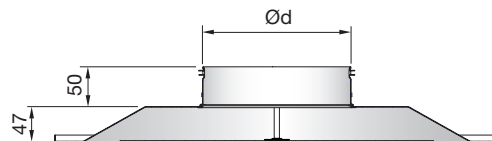

UK - Upper part adapted to ceiling system  
DK - Overpart tilpasses loftsystem  
SE - Övre delen av donet anpassas till undertaket  
FI - Yläosa sovitettu kattojärjestelmään  
DE - Oberteil für Deckensystem angepasst  
IT - Parte superiore adattata al controsoffitto  
FR - Partie supérieure adaptée au type de plafond

LCP

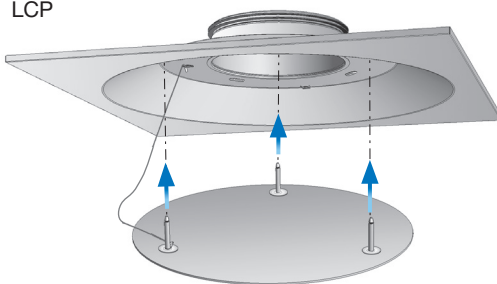

LCP-P-T

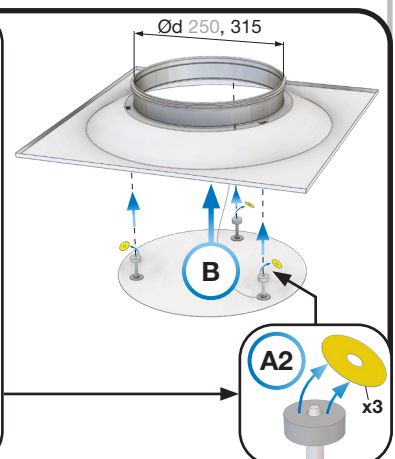
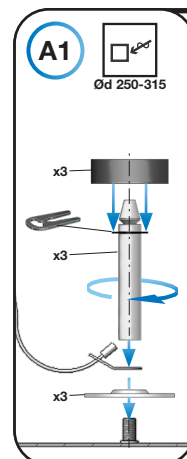
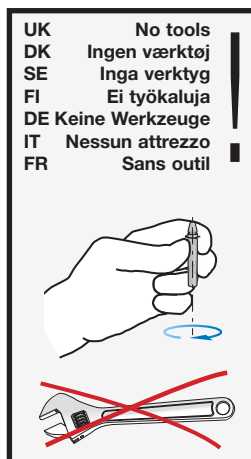
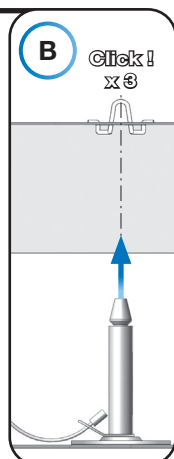
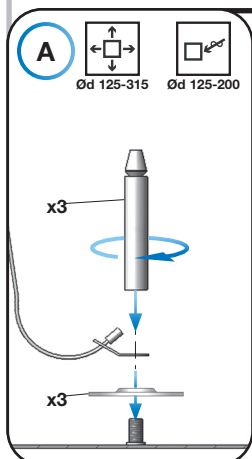
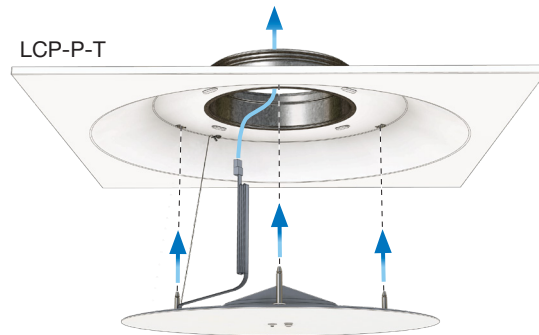

Order code  
Ordre kode  
Beställningskod  
Tuotekoodi  
Bestellcode  
Codice d'ordine  
Codification

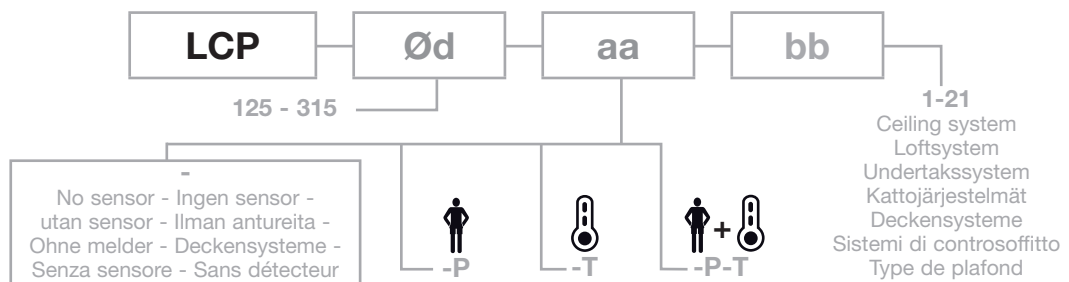

- MBZ - Optional accessories**
- MBZ - Ekstra tilbehør**
- MBZ - Tillbehör som tillval**
- MBZ - Lisävarusteet tilauksesta**
- MBZ - Zubehör**
- MBZ - Accessori su richiesta**
- MBZ - Accessoires optionnels**

## MBZ

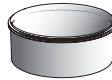

Extension piece  
 Forlængerstykke  
 Förlängningsstos  
 Jatkokappale  
 Verlängerungsstützen  
 Manicotto maschio femmina di prolungamento  
 Rallonge

- Order code**
- Ordre kode**
- Beställningskod**
- Tuotekoodi**
- Bestellcode**
- Codice d'ordine**
- Codification**

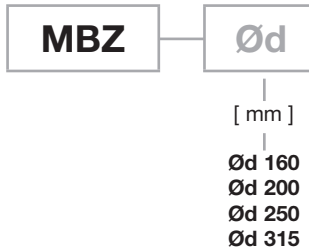

- Example: MBV
- Eksempel: 160-250-CN
- Exempel: +
- Esimerkki: MBZ
- Beispiel: +
- Esempio: LCP250
- Exemple:



**Ceiling systems    loftsystemer    Undertakssystem    Kattojärjestelmät    Deckensysteme**  
**Sistemi di controsoffitto    Systèmes de plafond**

**1.  
21.**

T24/T15 = 600 x 600  
21 = 625 x 625

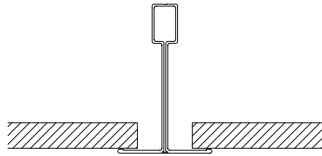

**2.  
22.**

T24/T15 = 600 x 600  
22 = 625 x 625

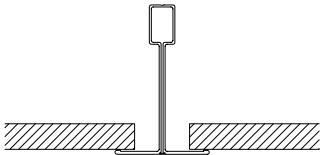

**3.**

**Permanent ceiling  
Fast loft / Fast undertak  
Kiinteä alakatto  
geschlossene decke  
Soffitto permanente  
Plafond non démontable**



**4.**

**Dampa Clip-in**

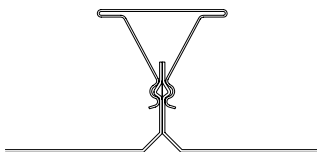

**5.**

**Dampa Clip-in**

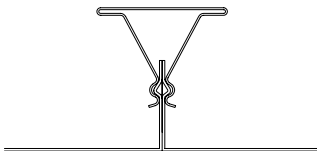

**6.**

**Luxalon Clip-in**

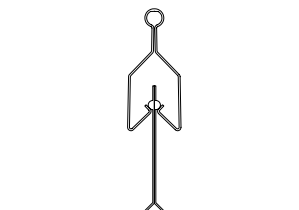

**7.**

**Danotile Contur / Ecophon D  
Rockfon D-XL**

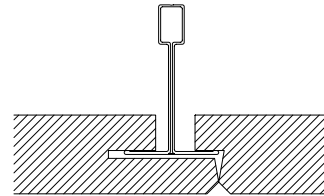

**8.**

**Ecophon Focus DG**

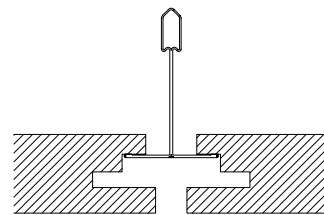

**9.**

**Rockfon E10 24 / Ecophon E / T24**

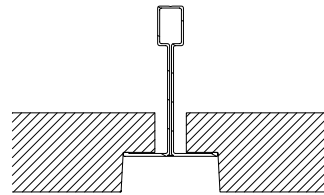

**10.**

**Rockfon E10 15 / Ecophon E / T15**

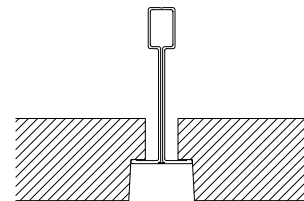

**11.**

**Danotile Markant**

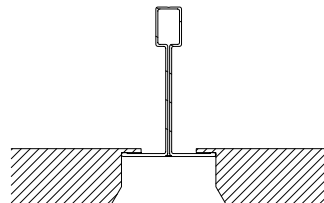

**14.**

**Ecophon Focus DS**

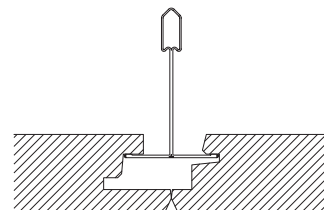

# Integra

Installation

Installation

Montage

Asennusohje

Montage

# LCP + MB

Montaggio

Montage

Installation of diffuser in MB  
 Montering af armatur i MB  
 Montering av don i MB  
 Hajottajan asennus MB-laatikoon  
 Durchlassmontage im MB  
 Montaggio del diffusore in MB  
 Montage du diffuseur dans MB



LCP Ød = MB Ød<sub>2</sub>

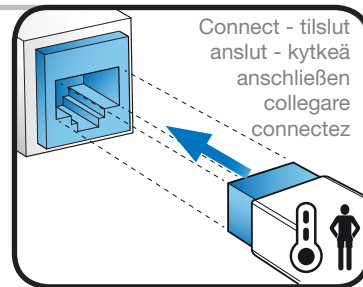

**LCP**  
 Ød = 160 - 250

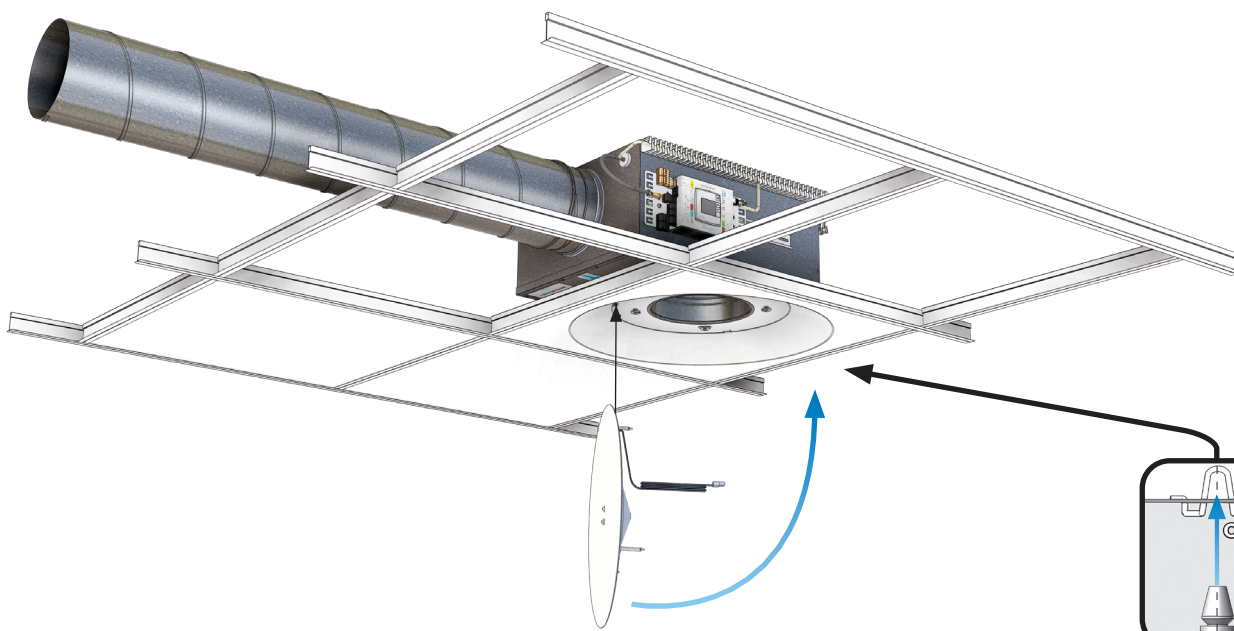
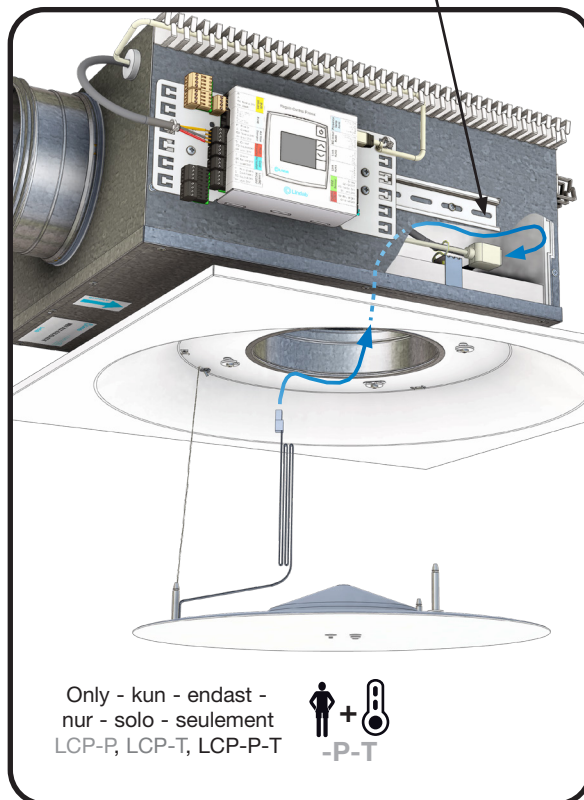
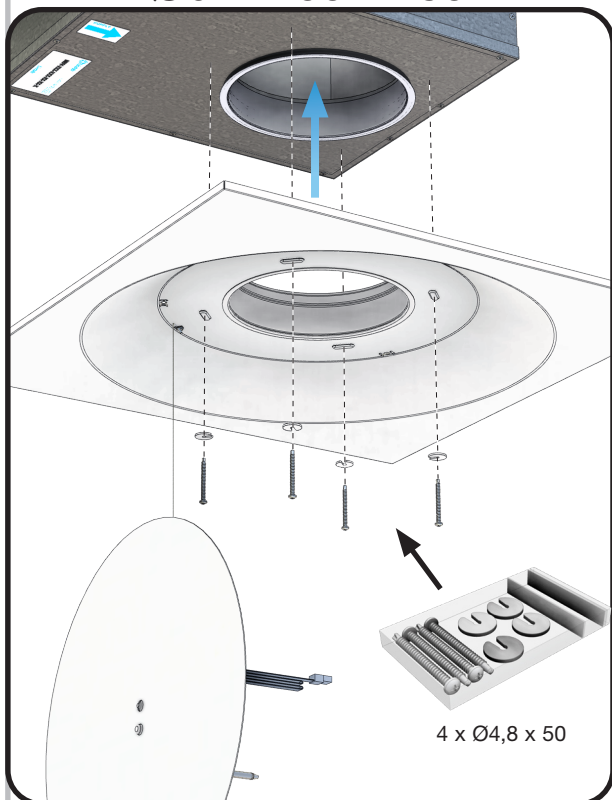



## Integra

Installation

Installation

Montage

Asennusohje

## LCP 315 + MB

Montage

Montaggio

Montage

Installation of diffuser in MB  
 Montering af armatur i MB  
 Montering av don i MB  
 Hajottajan asennus MB-laatikoon  
 Durchlassmontage im MB  
 Montaggio del diffusore in MB  
 Montage du diffuseur dans MB

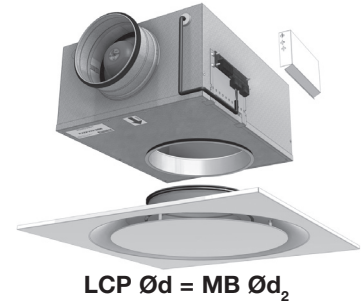

LCP  
 Ød = 315

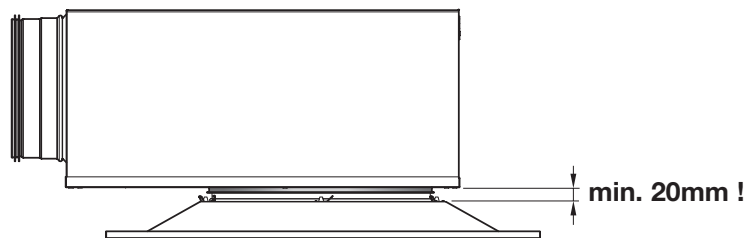

## Ød 315 !

NO holes for MB mounting on diffuser !  
 INGEN huller til MB montage på armaturet !  
 Inga hål för MB montering på donet  
 Ei reikiä MB asennukseen !  
 KEINE Löcher für montage im MB auf Durchlass !  
 Nessun foro per il montaggio del plenum MB al diffusore !  
 PAS de trous pour le montage du MB sur le diffuseur !

4 x Ø4,8 x 50



Not used  
 Anvendes ikke  
 Används inte  
 Ei käytetä  
 Nicht verwendet  
 Non utilizzate  
 Non utilisé

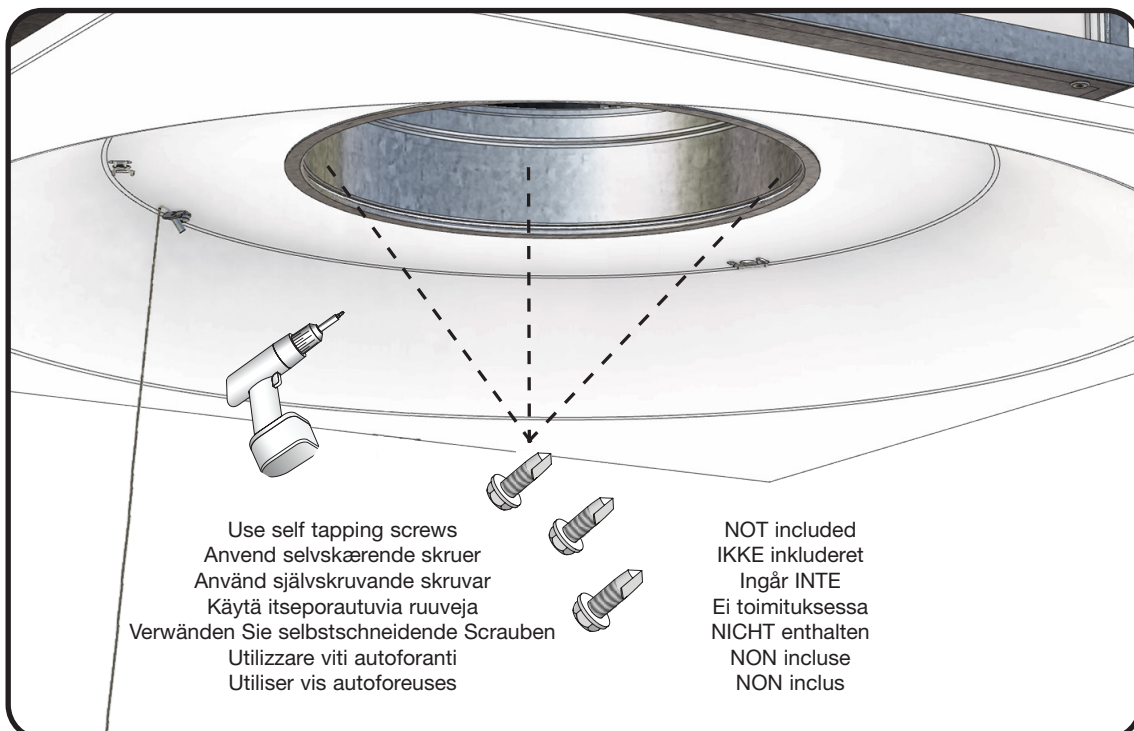

Use self tapping screws  
 Anvend selvskærende skruer  
 Använd självskruvande skruvar  
 Käytä itseporautuvia ruuveja  
 Verwenden Sie selbstschneidende Schrauben  
 Utilizzare viti autoforanti  
 Utiliser vis autoforeuses

NOT included  
 IKKE inkluderet  
 Ingår INTE  
 Ei toimituksessa  
 NICHT enthalten  
 NON include  
 NON inclus



Most of us spend the majority of our time indoors. Indoor climate is crucial to how we feel, how productive we are and if we stay healthy.

We at Lindab have therefore made it our most important objective to contribute to an indoor climate that improves people's lives. We do this by developing energy-efficient ventilation solutions and durable building products. We also aim to contribute to a better climate for our planet by working in a way that is sustainable for both people and the environment.

[Lindab | For a better climate](#)